

Data Sheet

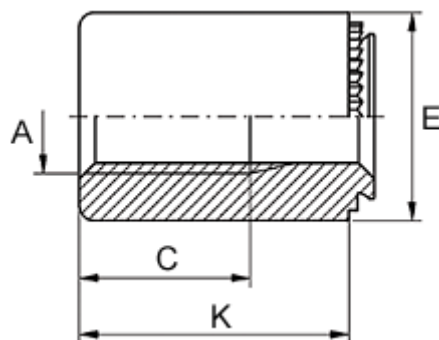

Article number: 12521800050500
Description: KLEE-coil 521 800 050.500
M5 Stainless 1.4305

Measures



Female thread A	= M5
Height K	= 21
Min distance to edge	= 4.0
Outer diameter E	= 9
Plate thickness	= 0.8 to 1.0
Recommended bore diameter +0.05	= 6.00
Thread length	= 8.0